



Podgorica Senior European Cup 2024

Montenegro, Podgorica, 21-22 Sep 2024

-60 kg
Seniors (12)

POOL A

	AMARASEKARA Egilsten	NOR
	GOSEDGE Connor	GBR
	AHMETI Ejsi	ALB

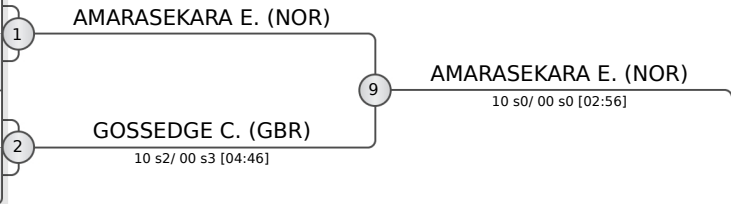

POOL B

	SIMEONOV Ivan	BUL
	HOWARD Benjamin	GER
	ANDJELOVIC Rastko	SRB

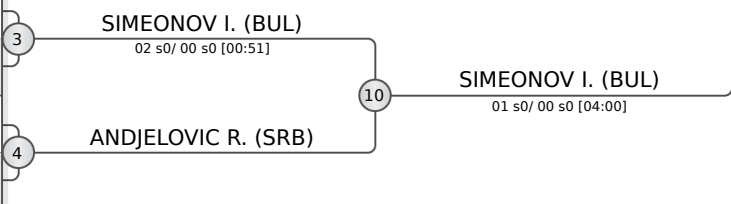

POOL C

	BLASZCZAK Igor	POL
	GRIGOROV Lyuboslav	BUL
	SASSI Thomas	ITA

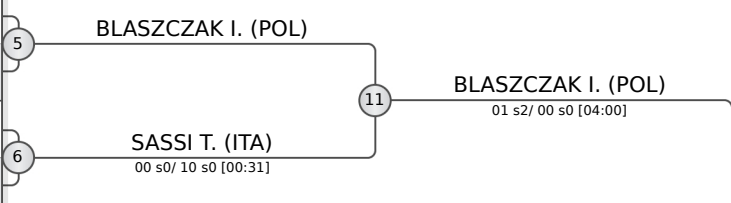

POOL D

	ZADRAVEC Gabriel	SLO
	MUSIC Ilija	MNE
	JORGIC Marko	SRB

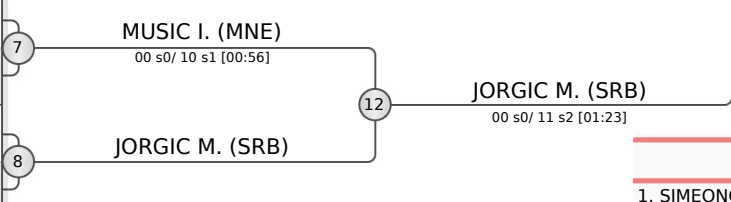

REPECHAGE

GOSEDGE C. (GBR)	13	GOSEDGE C. (GBR)
HOWARD B. (GER)	14	HOWARD B. (GER)
ANDJELOVIC R. (SRB)	14	HOWARD B. (GER)
SASSI T. (ITA)	15	SASSI T. (ITA)
MUSIC I. (MNE)	16	MUSIC I. (MNE)

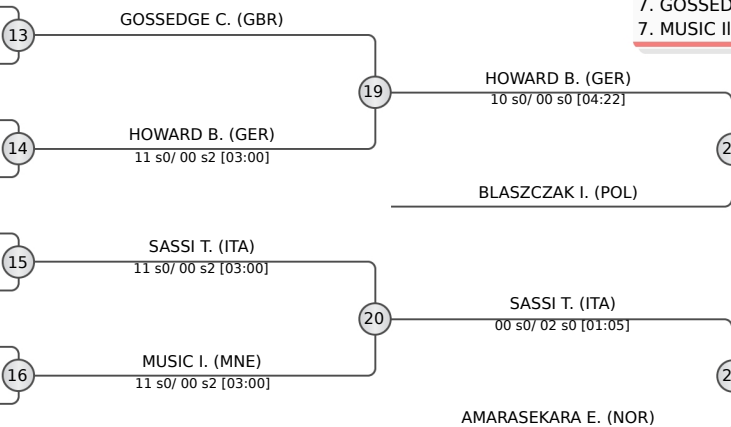

FINAL RESULTS		
1.	SIMEONOV Ivan	BUL
2.	JORGIC Marko	SRB
3.	HOWARD Benjamin	GER
3.	AMARASEKARA Egilsten	NOR
5.	BLASZCZAK Igor	POL
5.	SASSI Thomas	ITA
7.	GOSEDGE Connor	GBR
7.	MUSIC Ilija	MNE





Podgorica Senior European Cup 2024

Montenegro, Podgorica, 21-22 Sep 2024

-66 kg
Seniors (35)

POOL A

1	SEKNIJASVILI T. (SRB)	33	SEKNIJASVILI T. (SRB)
2	SINANOVIC E. (MNE)		10 s0/ 00 s0 [01:22]
3	FRIDMAN I. (ISR)	34	DEGHNOUCHE M. (FRA)
4	DEGHNOUCHE M. (FRA)		00 s2/ 10 s0 [02:52]
5	PETROVIC P. (SRB)	35	ICKES D. (GER)
6	ICKES D. (GER)		00 s2/ 01 s1 [06:13]
7	RADOVIC P. (MNE)	36	RADOVIC P. (MNE)
8	MCCRISTALL D. (CAN)		10 s0/ 01 s0 [03:14]

POOL B

9	ZENDER P. (POL)	37	ZENDER P. (POL)
10	PONOMARENKO R. (UKR)		10 s0/ 00 s0 [01:10]
11	SHERER Z. (ISR)	38	DE TULLIO G. (ITA)
12	DE TULLIO G. (ITA)		00 s0/ 10 s0 [00:50]
13	BERISA M. (MNE)	39	BERISA M. (MNE)
14	LOJANICIC M. (SRB)		10 s0/ 00 s0 [01:17]
15	GOC U. (TUR)	40	GOC U. (TUR)
16	HERRMANN L. (GER)		01 s0/ 00 s1 [04:00]

POOL C

17	KLIMKIEWICZ K. (POL)	41	KUJANHAARA J. (FIN)
18	KUJANHAARA J. (FIN)		00 s1/ 01 s1 [04:00]
19	KRSMANOVIC P. (SRB)	42	MAN O. (ISR)
20	MAN O. (ISR)		00 s0/ 02 s0 [03:04]
21	RIPSATER I. (SWE)	43	EDMEIER S. (GER)
22	EDMEIER S. (GER)		00 s0/ 10 s0 [03:42]
23	BASSET k. (ITA)	44	NURKOVIC J. (MNE)
24	NURKOVIC J. (MNE)		00 s3/ 11 s0 [02:13]

POOL D

25	KUNZE N. (GER)	45	KUNZE N. (GER)
26	KLACAR D. (CRO)		10 s2/ 00 s0 [07:37]
27	MIHIC N. (BIH)	46	NAPSO N. (ISR)
28	NAPSO N. (ISR)		00 s1/ 10 s0 [01:35]
29	KURPEJOVIC A. (MNE)	47	WEISSER P. (GER)
30	WEISSER P. (GER)		00 s0/ 11 s0 [01:12]
31	BERLINER A. (USA)	48	BERLINER A. (USA)
32	KEZIC Dusan (SRB)		10 s0/ 00 s0 [02:27]
	MAGNANO A. (ITA)		

REPECHAGE

61	PETROVIC P. (SRB)	65	RADOVIC P. (MNE)
			00 s1/ 10 s0 [03:42]
62	SHERER Z. (ISR)	66	SHERER Z. (ISR)
			11 s1/ 00 s0 [04:40]
63	BASSET k. (ITA)	67	EDMEIER S. (GER)
			00 s0/ 01 s0 [04:00]
64	KLACAR D. (CRO)	68	KLACAR D. (CRO)
			01 s0/ 00 s1 [04:45]

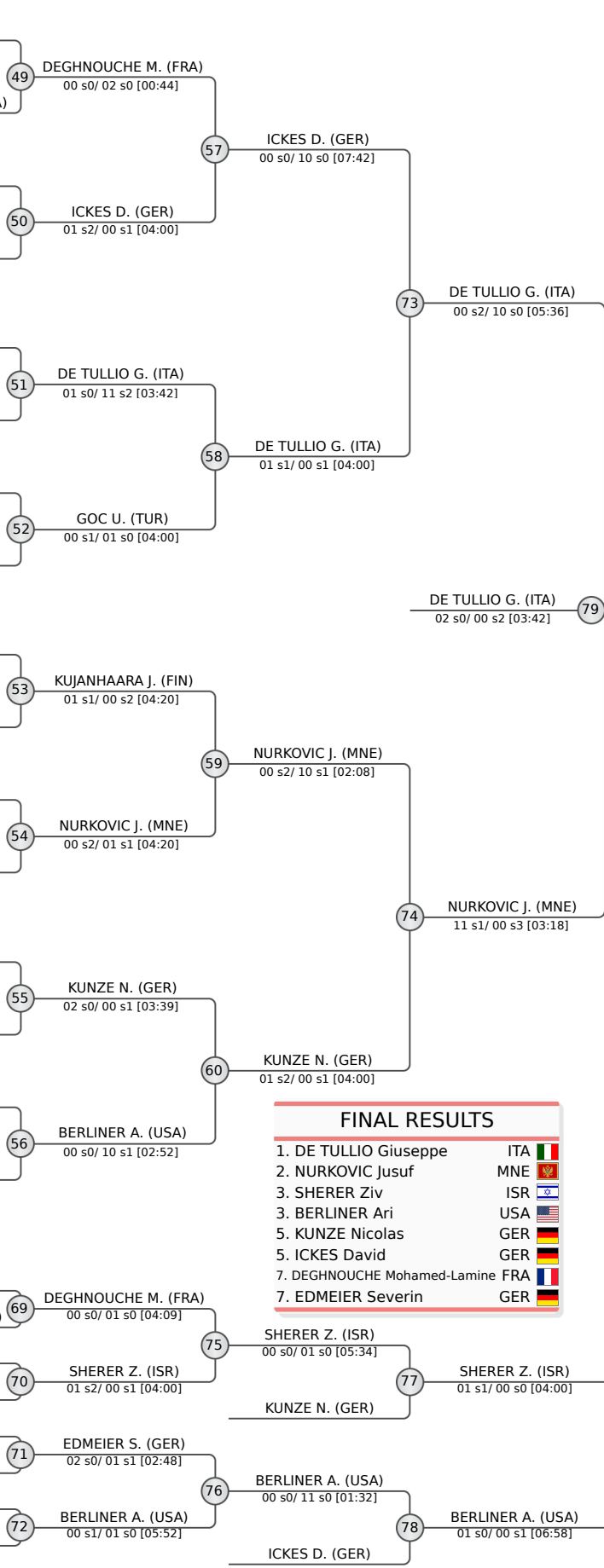

FINAL RESULTS

1.	DE TULLIO Giuseppe	ITA
2.	NURKOVIC Jusuf	MNE
3.	SHERER Ziv	ISR
3.	BERLINER Ari	USA
5.	KUNZE Nicolas	GER
5.	ICKES David	GER
7.	DEGHNOUCHE Mohamed-Lamine	FRA
7.	EDMEIER Severin	GER





Podgorica Senior European Cup 2024

Montenegro, Podgorica, 21-22 Sep 2024

-73 kg
Seniors (32)

POOL A

	KLACAR Robert	CRO
	NURKOVIC Jahja	MNE
	YONEZUKA Jack	USA
	HENRIKSSON Emil	SWE
	HACATRJAN Sos	SRB
	BRICI Luka	ALB
	LILLO Idan	ISR
	SENIC Mihailo	MNE

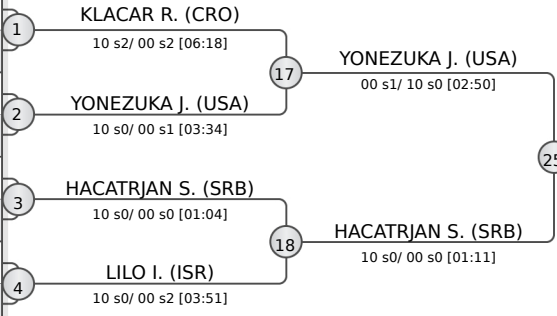

POOL B

	LOSKA Olaf	POL
	MAERKT Levi	GER
	GOGUA Theodoros	GRE
	KORHONEN Roope	FIN
	BOSIS Federico	ITA
	RAKOCEVIC Matija	MNE
	KAPELUSHNIK Daniel	ISR
	LAVRSEN Bertil	DEN

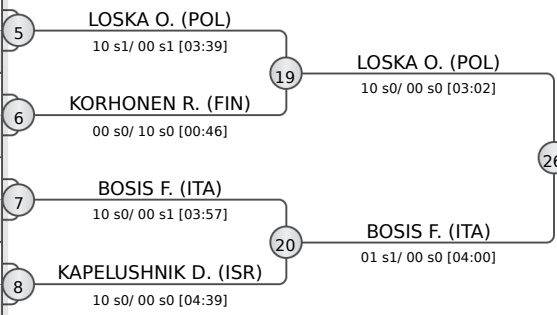

POOL C

	THOMAS Peter	GER
	BRENCE Miha	SLO
	TADIC Luka	MNE
	MERMELSHTEIN Almog	ISR
	GREENBANK Jordon	AUS
	CULLHAJ Indrit	ALB
	AGERTOFT Jacob	DEN
	PICHKHADZE David	ISR

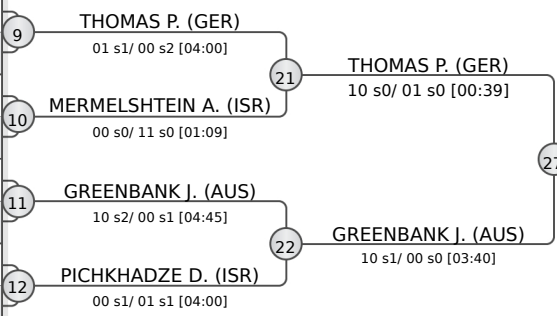

POOL D

	ABELTSHAUSER Kevin	GER
	BAGAJEV Bajsangur	SRB
	IOVINE Lorenzo	ITA
	HEFETZ Yoav	ISR
	CHARLES Cameron	GBR
	PERIC Timon	CRO
	DOBROVIC Vojin	MNE
	PANDUREVIC Srdjan	BIH

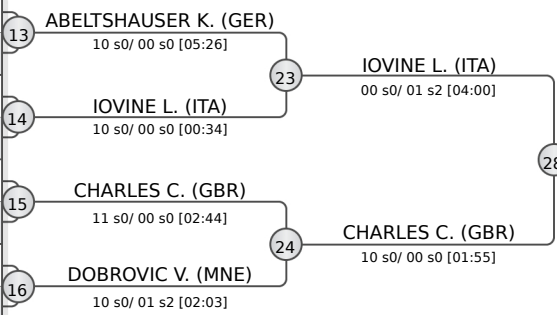

REPECHAGE

HENRIKSSON E. (SWE)	29	KLACAR R. (CRO)	33	KLACAR R. (CRO)
KLACAR R. (CRO)		HACATRJAN S. (SRB)		
RAKOCEVIC M. (MNE)	30	RAKOCEVIC M. (MNE)	34	RAKOCEVIC M. (MNE)
KAPELUSHNIK D. (ISR)		LOSKA O. (POL)		
BRENCE M. (SLO)	31	MERMELSHTEIN A. (ISR)	35	GREENBANK J. (AUS)
MERMELSHTEIN A. (ISR)		GREENBANK J. (AUS)		
HEFETZ Y. (ISR)	32	ABELTSHAUSER K. (GER)	36	ABELTSHAUSER K. (GER)
ABELTSHAUSER K. (GER)		CHARLES C. (GBR)		

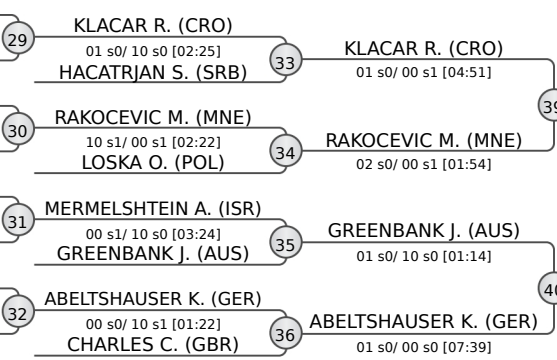

FINAL RESULTS	
1. THOMAS Peter	GER
2. YONEZUKA Jack	USA
3. KLACAR Robert	CRO
3. ABELTSHAUSER Kevin	GER
5. IOVINE Lorenzo	ITA
5. BOSIS Federico	ITA
7. RAKOCEVIC Matija	MNE
7. GREENBANK Jordon	AUS





Podgorica Senior European Cup 2024

Montenegro, Podgorica, 21-22 Sep 2024

-63 kg
Seniors (17)

POOL A

	SEDLMAIR Hanna	GER
	CVJETKO Nina	CRO
	LISCIANI Sara	ITA
	WATOREK Oliwia	POL

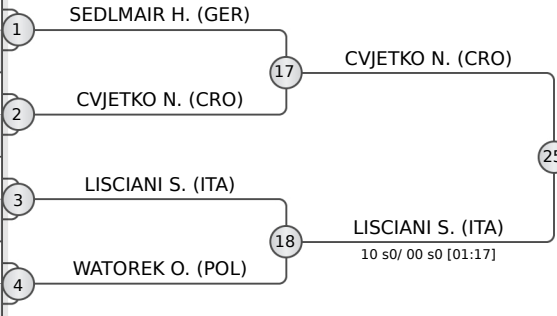

POOL B

	CHRISTENSEN Helene	DEN
	CHRISTIE Qona	NZL
	VLAHOVIC Teodora	MNE
	OSTLIND Gretha	SWE

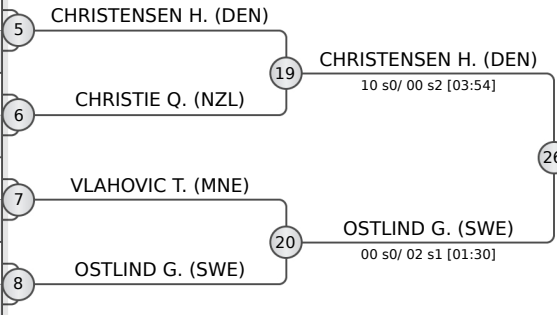

POOL C

	SZAFRAN Agata	POL
	LOWRY Robin	IRL
	LAUBER Natascha	GER
	ANDERSSON Ella	SWE

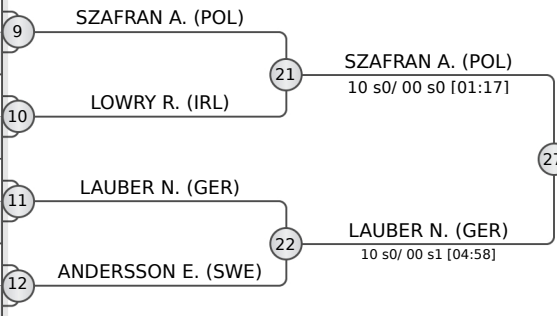

POOL D

	JAWOROWSKI Naemi	SWE
	PONCET Charlotte	FRA
	BAUER Bettina	GER
	SALKARBK KIZI Dilbara	SRB
	COUGHLAN Maeve	AUS

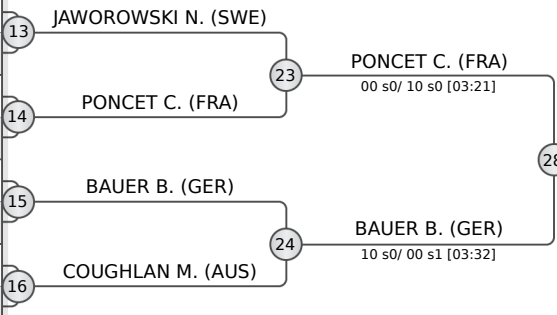

FINAL RESULTS	
1.	LISCIANI Sara
2.	BAUER Bettina
3.	CHRISTIE Qona
3.	SALKARBK KIZI Dilbara
5.	LAUBER Natascha
5.	CHRISTENSEN Helene
7.	CVJETKO Nina
7.	SZAFRAN Agata

REPECHAGE

WATOREK O. (POL) (29)	WATOREK O. (POL)
CHRISTIE Q. (NZL) (30)	CHRISTIE Q. (NZL)
ANDERSSON E. (SWE) (31)	ANDERSSON E. (SWE)
SALKARBK KIZI D. (SRB) (32)	SALKARBK KIZI D. (SRB)
COUGHLAN M. (AUS) (32)	COUGHLAN M. (AUS)

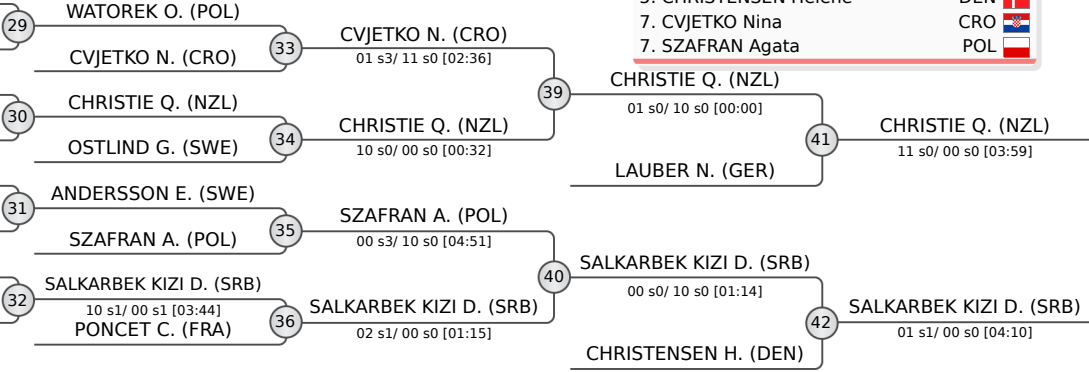



Podgorica Senior European Cup 2024

Montenegro, Podgorica, 21-22 Sep 2024

-70 kg
Seniors (11)

POOL A

	VIOLIC Andela	CRO
	JAKOBSEN Ida	DEN
	PEDROTTI Irene	ITA

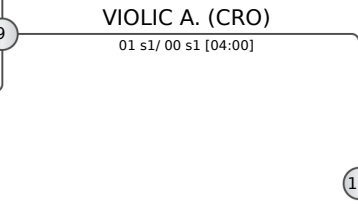
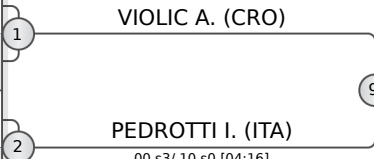

POOL B

	GORGUET-VERANES Maidelines	ROU
	ZADVORNOVA Ksenia	IJF

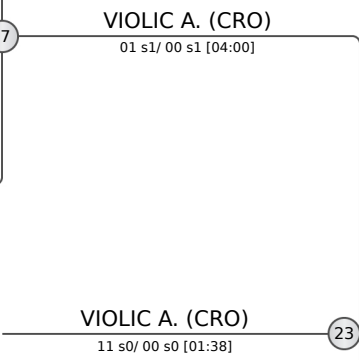
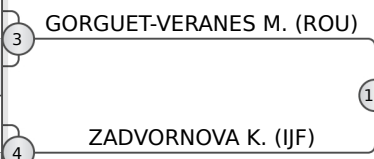

POOL C

	BECKER Celine	GER
	MIDDLETON Saya	AUS
	BARICEVIC Lucija	CRO

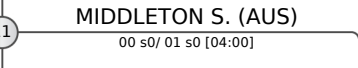
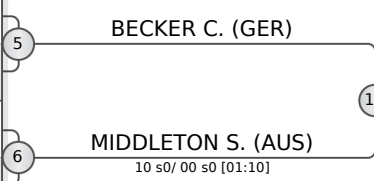

POOL D

	SPEROTTI Claudia	ITA
	SUTOVIC Andrijana	MNE
	SUCIU Anamaria	ROU

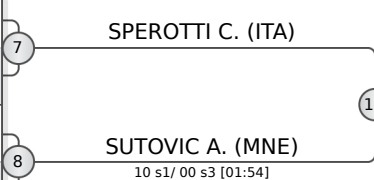

FINAL RESULTS		
1.	VIOLIC Andela	CRO
2.	SPEROTTI Claudia	ITA
3.	PEDROTTI Irene	ITA
3.	ZADVORNOVA Ksenia	IJF
5.	MIDDLETON Saya	AUS
5.	BECKER Celine	GER
7.	GORGUET-VERANES Maidelines	ROU
7.	SUTOVIC Andrijana	MNE

REPECHAGE

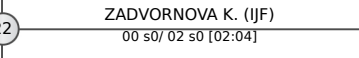
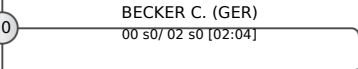
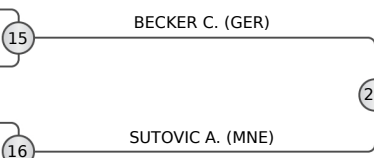
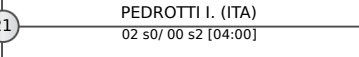
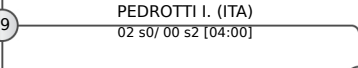
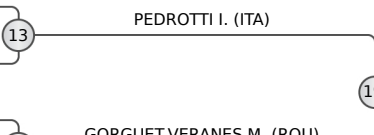



Podgorica Senior European Cup 2024

Montenegro, Podgorica, 21-22 Sep 2024

-78 kg
Seniors (11)

POOL A

	PAVIC Petrunjela	CRO
	SWAN Maria	AUS
	STJEPANOVIC Jovana	SRB

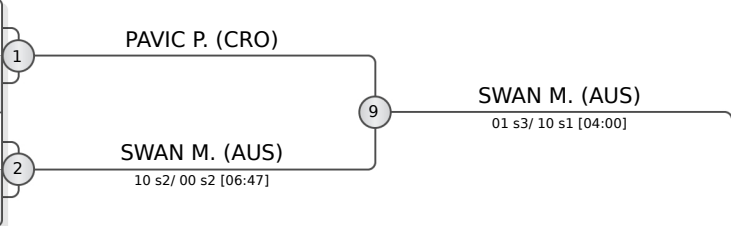

POOL B

	TUREK Aleksandra	POL
	GOBEC Lea	CRO
	TOCCI Rossana	ITA

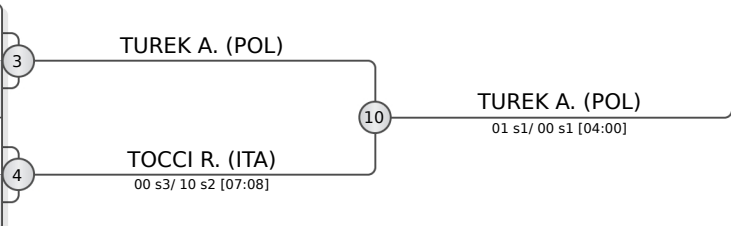

POOL C

	HOELTERHOFF Julie	GER
	DOLGILEVICA Una	LAT

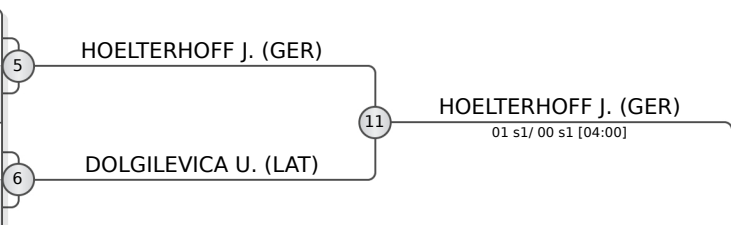

POOL D

	PEKOVIC Jovana	MNE
	MUSZYNSKA Paulina	POL
	PERKOVIC Lorena	CRO

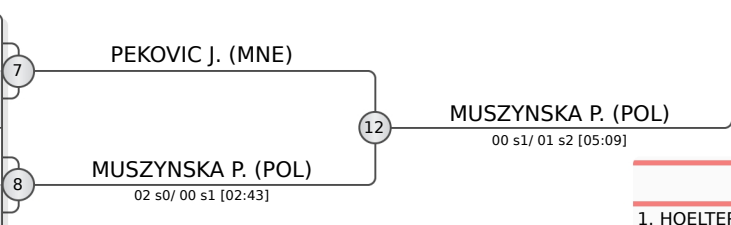

REPECHAGE

STJEPANOVIC J. (SRB)	PAVIC P. (CRO)	13
PAVIC P. (CRO)	TOCCI R. (ITA)	14
DOLGILEVICA U. (LAT)	PERKOVIC L. (CRO)	15
PERKOVIC L. (CRO)	PEKOVIC J. (MNE)	16

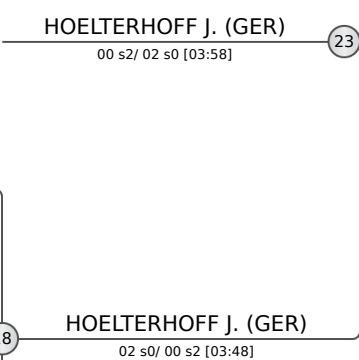
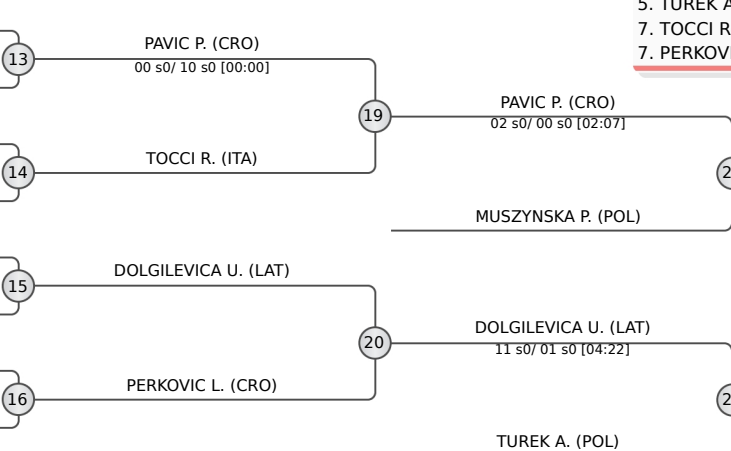

FINAL RESULTS		
1.	HOELTERHOFF Julie	GER
2.	SWAN Maria	AUS
3.	PAVIC Petrunjela	CRO
3.	DOLGILEVICA Una	LAT
5.	MUSZYNSKA Paulina	POL
5.	TUREK Aleksandra	POL
7.	TOCCI Rossana	ITA
7.	PERKOVIC Lorena	CRO





Podgorica Senior European Cup 2024

Montenegro, Podgorica, 21-22 Sep 2024

+ 78 kg
Seniors (7)

POOL A

MARANIC Ivana CRO

MARANIC I. (CRO)

POOL B

MRVALJEVIC Jovana MNE
 JANJIC Tara SLO

MRVALJEVIC J. (MNE)

11 s0/ 00 s0 [01:15]

POOL C

BOGDANOVIC Anastasija SRB
 CHOLOMBITKO Albina IJF

CHOLOMBITKO A. (IJF)

00 s0/ 02 s0 [00:41]

POOL D

KUESTER Amani GER
 VULPASIN Maria-Nicoleta GRE

KUESTER A. (GER)

02 s0/ 00 s2 [03:36]

REPECHAGE

JANJIC T. (SLO)

JANJIC T. (SLO)

BOGDANOVIC A. (SRB)
VULPASIN M. (GRE)

BOGDANOVIC A. (SRB)

02 s1/ 00 s1 [02:22]

MRVALJEVIC J. (MNE)

JANJIC T. (SLO)

11 s0/ 00 s1 [03:31]

BOGDANOVIC A. (SRB)

11 s0/ 00 s1 [03:31]

5

MARANIC I. (CRO)

01 s1/ 00 s1 [04:00]

11

CHOLOMBITKO A. (IJF)

00 s0/ 10 s1 [02:43]

FINAL RESULTS

- CHOLOMBITKO Albina IJF
- MARANIC Ivana CRO
- JANJIC Tara SLO
- BOGDANOVIC Anastasija SRB
- KUESTER Amani GER
- MRVALJEVIC Jovana MNE

