



# Thessaloniki Cadet European Cup 2024

Greece, Thessaloniki, 23-24 Nov 2024

**-73 kg**  
Cadets (47)

**POOL A**

	KULLO Tits	LAT
	VLAEV Bogdan	BUL
	CHERKAVSKY Maxim	ISR
	SHARIFOV Said	AZE
	PREDA Emanuel	ROU
	GIVISHVILI Giorgi	GEO
	PAVLOVIC Fredi	CRO
	JEREMIC Atanasije	SRB
	KADRIC Denis	BIH
	MIHALEV Nikolaz	BUL
	PETROSSIAN Garry	CYP
	ANDRONOPOULOS Nikolaos	GRE

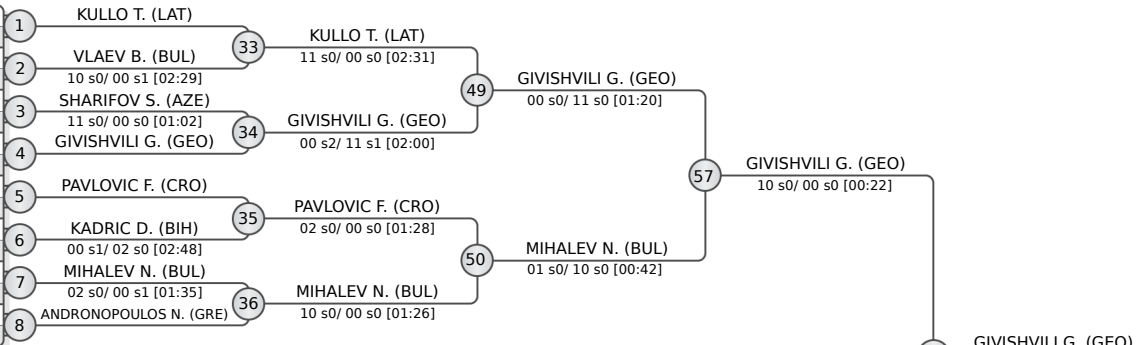

**POOL B**

	DINEV Aleksandar	BUL
	KAZOUKAS Georgios	GRE
	JUKA Stefan	BIH
	MACHURIDZE Vladimer	GEO
	HAYOUNE HAGBY Avi Shalom	ISR
	MORICONI Daniele	ITA
	PEPPOS Viktoras	CYP
	GAMEZARDASHVILI Vasil	GEO
	PAPADOPOULOS Georgios	GRE
	REBELO OSORIO Marcos	LUX
	HERMANSKI Szymon	POL

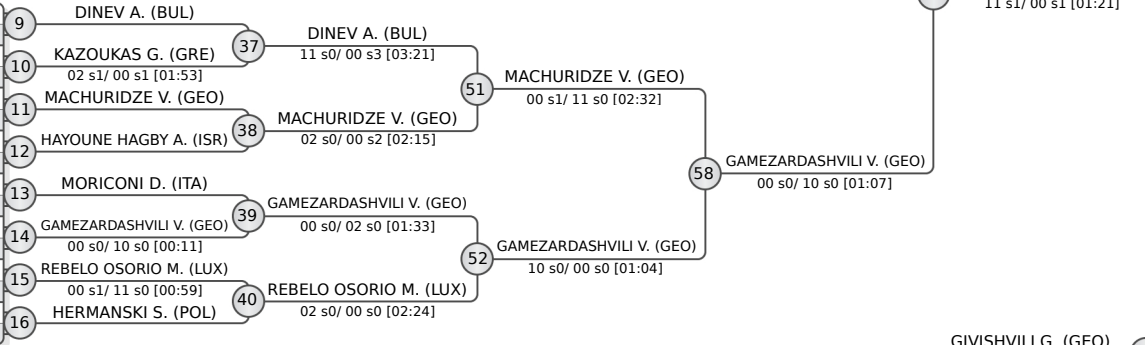

**POOL C**

	BORZECKI Jakub	POL
	CHARALAMPOUS Vladimiro	CYP
	DIJURISIC Balsa	MNE
	DJORDJEVIC Jovan	SRB
	KATRANIDIS Ioannis	GRE
	SULJKANOVIC Ajdin	BIH
	MERCEA David Emanuel	ROU
	ANASTASIADIS Dionysios	GRE
	KURDGELASHVILI Nikoloz	GEO
	KAGLATZIS Panagiotis	CYP
	REISFELD Moran	ISR
	GELEV Bozhidar	BUL

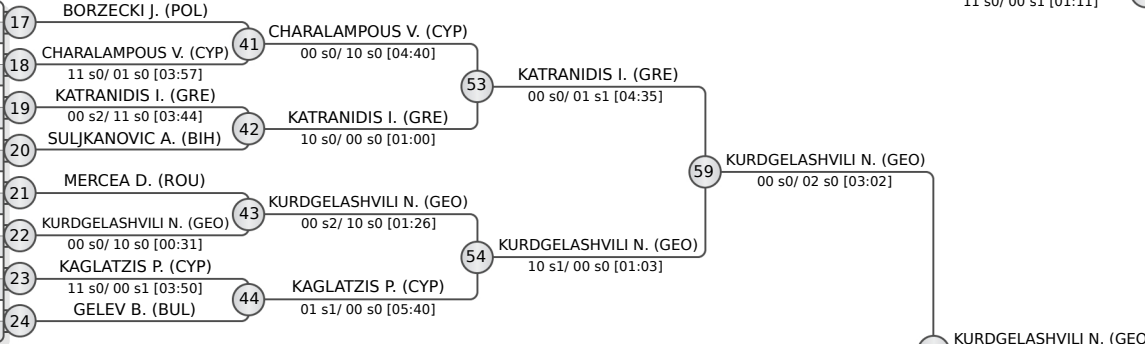

**POOL D**

	SPETSIOS Kyriakos	CYP
	AGHAKISHIYEV Mahammad	AZE
	DAMIANIDIS Vasileios	GRE
	KAMKAMIDZE Tengiz	GEO
	NATKHO Ryan	ISR
	DIMITROV Dimitar	BUL
	MAKSIMOVIC Vuk	BIH
	CHIKH Riad	FRA
	PERALOVIC Uros	SRB
	GKOLIAS Efthymios	GRE
	SAMSIANI Ieso	GEO
	GAVRAILOV Nikolay	BUL

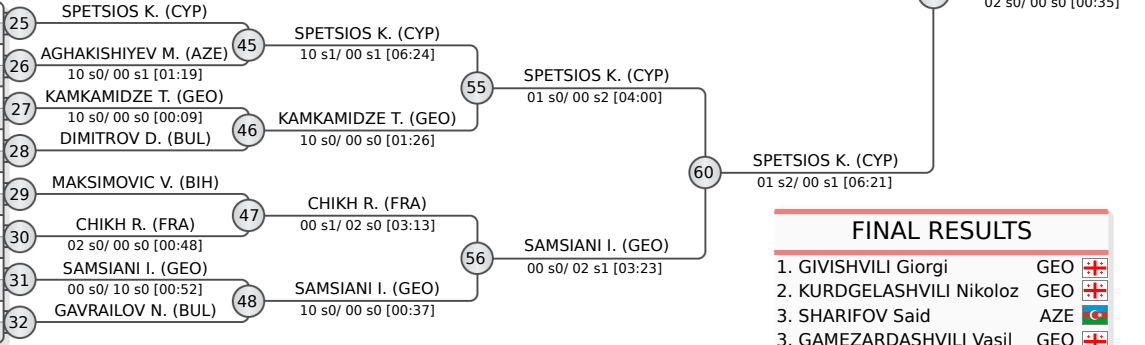

FINAL RESULTS	
1.	GIVISHVILI Giorgi GEO
2.	KURDGELASHVILI Nikoloz GEO
3.	SHARIFOV Said AZE
3.	GAMEZARDASHVILI Vasil GEO
5.	SPETSIOS Kyriakos CYP
7.	MERCEA David Emanuel ROU
7.	MACHURIDZE Vladimer GEO
7.	AGHAKISHIYEV Mahammad AZE

**REPECHAGE**

SHARIFOV S. (AZE)	61	SHARIFOV S. (AZE)
PEPPOS V. (CYP)	62	PEPPOS V. (CYP)
MORICONI D. (ITA)	63	MORICONI D. (ITA)
ANASTASIADIS D. (GRE)	64	ANASTASIADIS D. (GRE)
MERCEA D. (ROU)	65	MERCEA D. (ROU)
AGHAKISHIYEV M. (AZE)	66	AGHAKISHIYEV M. (AZE)
SHARIFOV S. (AZE)	67	SHARIFOV S. (AZE)
KULLO T. (LAT)	68	KULLO T. (LAT)
MIHALEV N. (BUL)	69	MIHALEV N. (BUL)
REBELO OSORIO M. (LUX)	70	REBELO OSORIO M. (LUX)
MACHURIDZE V. (GEO)	71	MACHURIDZE V. (GEO)
MERCEA D. (ROU)	72	MERCEA D. (ROU)
AGHAKISHIYEV M. (AZE)	73	AGHAKISHIYEV M. (AZE)
SAMSIANI I. (GEO)	74	SAMSIANI I. (GEO)
SHARIFOV S. (AZE)	75	SHARIFOV S. (AZE)
MIHALEV N. (BUL)	76	MIHALEV N. (BUL)
REBELO OSORIO M. (LUX)	77	REBELO OSORIO M. (LUX)
MACHURIDZE V. (GEO)	78	MACHURIDZE V. (GEO)
MERCEA D. (ROU)	79	MERCEA D. (ROU)
AGHAKISHIYEV M. (AZE)	80	AGHAKISHIYEV M. (AZE)
SAMSIANI I. (GEO)	81	SAMSIANI I. (GEO)
SHARIFOV S. (AZE)	82	SHARIFOV S. (AZE)
MIHALEV N. (BUL)	83	MIHALEV N. (BUL)
REBELO OSORIO M. (LUX)	84	REBELO OSORIO M. (LUX)
MACHURIDZE V. (GEO)	85	MACHURIDZE V. (GEO)
MERCEA D. (ROU)	86	MERCEA D. (ROU)
AGHAKISHIYEV M. (AZE)	87	AGHAKISHIYEV M. (AZE)
SAMSIANI I. (GEO)	88	SAMSIANI I. (GEO)
SHARIFOV S. (AZE)	89	SHARIFOV S. (AZE)
MIHALEV N. (BUL)	90	MIHALEV N. (BUL)
REBELO OSORIO M. (LUX)	91	REBELO OSORIO M. (LUX)
MACHURIDZE V. (GEO)	92	MACHURIDZE V. (GEO)
MERCEA D. (ROU)	93	MERCEA D. (ROU)
AGHAKISHIYEV M. (AZE)	94	AGHAKISHIYEV M. (AZE)
SAMSIANI I. (GEO)	95	SAMSIANI I. (GEO)
SHARIFOV S. (AZE)	96	SHARIFOV S. (AZE)
MIHALEV N. (BUL)	97	MIHALEV N. (BUL)
REBELO OSORIO M. (LUX)	98	REBELO OSORIO M. (LUX)
MACHURIDZE V. (GEO)	99	MACHURIDZE V. (GEO)
MERCEA D. (ROU)	100	MERCEA D. (ROU)
AGHAKISHIYEV M. (AZE)	101	AGHAKISHIYEV M. (AZE)
SAMSIANI I. (GEO)	102	SAMSIANI I. (GEO)
SHARIFOV S. (AZE)	103	SHARIFOV S. (AZE)
MIHALEV N. (BUL)	104	MIHALEV N. (BUL)
REBELO OSORIO M. (LUX)	105	REBELO OSORIO M. (LUX)
MACHURIDZE V. (GEO)	106	MACHURIDZE V. (GEO)
MERCEA D. (ROU)	107	MERCEA D. (ROU)
AGHAKISHIYEV M. (AZE)	108	AGHAKISHIYEV M. (AZE)
SAMSIANI I. (GEO)	109	SAMSIANI I. (GEO)
SHARIFOV S. (AZE)	110	SHARIFOV S. (AZE)
MIHALEV N. (BUL)	111	MIHALEV N. (BUL)
REBELO OSORIO M. (LUX)	112	REBELO OSORIO M. (LUX)
MACHURIDZE V. (GEO)	113	MACHURIDZE V. (GEO)
MERCEA D. (ROU)	114	MERCEA D. (ROU)
AGHAKISHIYEV M. (AZE)	115	AGHAKISHIYEV M. (AZE)
SAMSIANI I. (GEO)	116	SAMSIANI I. (GEO)
SHARIFOV S. (AZE)	117	SHARIFOV S. (AZE)
MIHALEV N. (BUL)	118	MIHALEV N. (BUL)
REBELO OSORIO M. (LUX)	119	REBELO OSORIO M. (LUX)
MACHURIDZE V. (GEO)	120	MACHURIDZE V. (GEO)
MERCEA D. (ROU)	121	MERCEA D. (ROU)
AGHAKISHIYEV M. (AZE)	122	AGHAKISHIYEV M. (AZE)
SAMSIANI I. (GEO)	123	SAMSIANI I. (GEO)
SHARIFOV S. (AZE)	124	SHARIFOV S. (AZE)
MIHALEV N. (BUL)	125	MIHALEV N. (BUL)
REBELO OSORIO M. (LUX)	126	REBELO OSORIO M. (LUX)
MACHURIDZE V. (GEO)	127	MACHURIDZE V. (GEO)
MERCEA D. (ROU)	128	MERCEA D. (ROU)
AGHAKISHIYEV M. (AZE)	129	AGHAKISHIYEV M. (AZE)
SAMSIANI I. (GEO)	130	SAMSIANI I. (GEO)
SHARIFOV S. (AZE)	131	SHARIFOV S. (AZE)
MIHALEV N. (BUL)	132	MIHALEV N. (BUL)
REBELO OSORIO M. (LUX)	133	REBELO OSORIO M. (LUX)
MACHURIDZE V. (GEO)	134	MACHURIDZE V. (GEO)
MERCEA D. (ROU)	135	MERCEA D. (ROU)
AGHAKISHIYEV M. (AZE)	136	AGHAKISHIYEV M. (AZE)
SAMSIANI I. (GEO)	137	SAMSIANI I. (GEO)
SHARIFOV S. (AZE)	138	SHARIFOV S. (AZE)
MIHALEV N. (BUL)	139	MIHALEV N. (BUL)
REBELO OSORIO M. (LUX)	140	REBELO OSORIO M. (LUX)
MACHURIDZE V. (GEO)	141	MACHURIDZE V. (GEO)
MERCEA D. (ROU)	142	MERCEA D. (ROU)
AGHAKISHIYEV M. (AZE)	143	AGHAKISHIYEV M. (AZE)
SAMSIANI I. (GEO)	144	SAMSIANI I. (GEO)
SHARIFOV S. (AZE)	145	SHARIFOV S. (AZE)
MIHALEV N. (BUL)	146	MIHALEV N. (BUL)
REBELO OSORIO M. (LUX)	147	REBELO OSORIO M. (LUX)
MACHURIDZE V. (GEO)	148	MACHURIDZE V. (GEO)
MERCEA D. (ROU)	149	MERCEA D. (ROU)
AGHAKISHIYEV M. (AZE)	150	AGHAKISHIYEV M. (AZE)
SAMSIANI I. (GEO)	151	SAMSIANI I. (GEO)
SHARIFOV S. (AZE)	152	SHARIFOV S. (AZE)
MIHALEV N. (BUL)	153	MIHALEV N. (BUL)
REBELO OSORIO M. (LUX)	154	REBELO OSORIO M. (LUX)
MACHURIDZE V. (GEO)	155	MACHURIDZE V. (GEO)
MERCEA D. (ROU)	156	MERCEA D. (ROU)
AGHAKISHIYEV M. (AZE)	157	AGHAKISHIYEV M. (AZE)
SAMSIANI I. (GEO)	158	SAMSIANI I. (GEO)
SHARIFOV S. (AZE)	159	SHARIFOV S. (AZE)
MIHALEV N. (BUL)	160	MIHALEV N. (BUL)
REBELO OSORIO M. (LUX)	161	REBELO OSORIO M. (LUX)
MACHURIDZE V. (GEO)	162	MACHURIDZE V. (GEO)
MERCEA D. (ROU)	163	MERCEA D. (ROU)
AGHAKISHIYEV M. (AZE)	164	AGHAKISHIYEV M. (AZE)
SAMSIANI I. (GEO)	165	SAMSIANI I. (GEO)
SHARIFOV S. (AZE)	166	SHARIFOV S. (AZE)
MIHALEV N. (BUL)	167	MIHALEV N. (BUL)
REBELO OSORIO M. (LUX)	168	REBELO OSORIO M. (LUX)
MACHURIDZE V. (GEO)	169	MACHURIDZE V. (GEO)
MERCEA D. (ROU)	170	MERCEA D. (ROU)
AGHAKISHIYEV M. (AZE)	171	AGHAKISHIYEV M. (AZE)
SAMSIANI I. (GEO)	172	SAMSIANI I. (GEO)
SHARIFOV S. (AZE)	173	SHARIFOV S. (AZE)
MIHALEV N. (BUL)	174	MIHALEV N. (BUL)
REBELO OSORIO M. (LUX)	175	REBELO OSORIO M. (LUX)
MACHURIDZE V. (GEO)	176	MACHURIDZE V. (GEO)
MERCEA D. (ROU)	177	MERCEA D. (ROU)
AGHAKISHIYEV M. (AZE)	178	AGHAKISHIYEV M. (AZE)
SAMSIANI I. (GEO)	179	SAMSIANI I. (GEO)
SHARIFOV S. (AZE)	180	SHARIFOV S. (AZE)
MIHALEV N. (BUL)	181	MIHALEV N. (BUL)
REBELO OSORIO M. (LUX)	182	REBELO OSORIO M. (LUX)
MACHURIDZE V. (GEO)	183	MACHURIDZE V. (GEO)
MERCEA D. (ROU)	184	MERCEA D. (ROU)
AGHAKISHIYEV M. (AZE)	185	AGHAKISHIYEV M. (AZE)
SAMSIANI I. (GEO)	186	SAMSIANI I. (GEO)
SHARIFOV S. (AZE)	187	SHARIFOV S. (AZE)
MIHALEV N. (BUL)	188	MIHALEV N. (BUL)
REBELO OSORIO M. (LUX)	189	REBELO OSORIO M. (LUX)
MACHURIDZE V. (GEO)	190	MACHURIDZE V. (GEO)
MERCEA D. (ROU)	191	MERCEA D. (ROU)
AGHAKISHIYEV M. (AZE)	192	AGHAKISHIYEV M. (AZE)
SAMSIANI I. (GEO)	193	SAMSIANI I. (GEO)
SHARIFOV S. (AZE)	194	SHARIFOV S. (AZE)
MIHALEV N. (BUL)	195	MIHALEV N. (BUL)
REBELO OSORIO M. (LUX)	196	REBELO OSORIO M. (LUX)
MACHURIDZE V. (GEO)	197	MACHURIDZE V. (GEO)
MERCEA D. (ROU)	198	MERCEA D. (ROU)
AGHAKISHIYEV M. (AZE)	199	AGHAKISHIYEV M. (AZE)
SAMSIANI I. (GEO)	200	SAMSIANI I. (GEO)





# Thessaloniki Cadet European Cup 2024

Greece, Thessaloniki, 23-24 Nov 2024

**-81 kg**  
Cadets (38)

**POOL A**

1	MUKHUM Rassul (KAZ)	33	MUKHUM R. (KAZ)
2	STATHOPOULOS Tryfonas (GRE)	34	SOLHAUG F. (NOR)
3	ORFANOS Athanasios (CYP)	35	MOGILNI K. (ISR)
4	ZOARETZ Tomer (ISR)	36	RAHMATOV A. (AZE)
5	SOLHAUG Fredrik Holm (NOR)	37	BUMAZKINS J. (LAT)
6	MOGILNI Kirill (ISR)	38	ABBASALI M. (AZE)
7	TCHENDJE KENMEUE Arthur (FRA)	39	GELASHVILI L. (GEO)
8	BOUKOUVALAS Agathoklis-Aris (GRE)	40	SARGHEOLIU A. (MDA)
	RAHMATOV Abdullah (AZE)		
	KATSARSKI Teodor (BUL)		

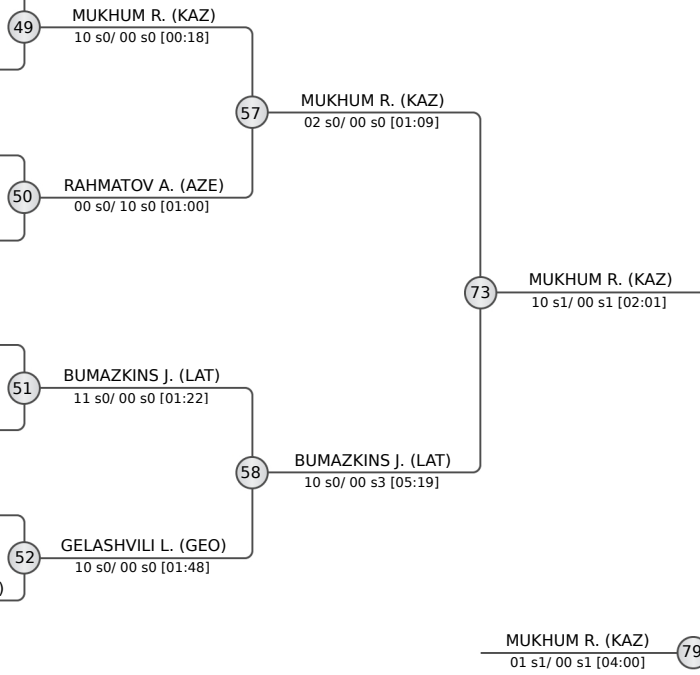

**POOL B**

9	BUMAZKINS Jelisejs (LAT)	37	BUMAZKINS J. (LAT)
10	MARKOVIC Matija (MNE)	38	ABBASALI M. (AZE)
11	NTAVITANTZE Loukas (GRE)	39	GELASHVILI L. (GEO)
12	MAN Darius (ROU)	40	SARGHEOLIU A. (MDA)
13	ABBASALI Mahammad (AZE)	41	BABAICENKO T. (LTU)
14	GELASHVILI Levan (GEO)	42	BAKHTADZE T. (GEO)
15	SHNIDER Omer (ISR)	43	CHARALAMPOUS M. (CYP)
16	GIANNAKOS Dimitrios (GRE)	44	NIANE E. (NOR)
	SARGHEOLIU Alexandru (MDA)		

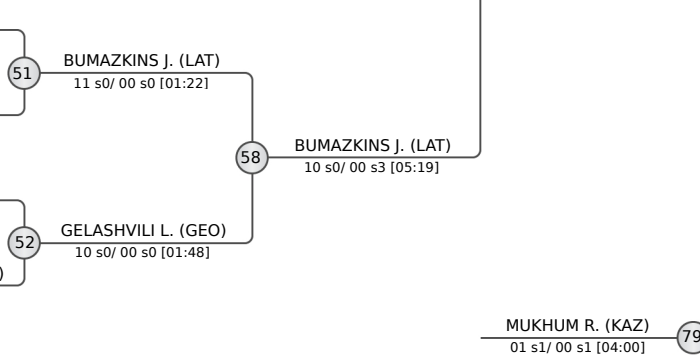

**POOL C**

17	BABAICENKO Tajus (LTU)	41	BABAICENKO T. (LTU)
18	LARIOS Anastasios (GRE)	42	BAKHTADZE T. (GEO)
19	FOGEL Alon (ISR)	43	CHARALAMPOUS M. (CYP)
20	BAKHTADZE Tsotne (GEO)	44	NIANE E. (NOR)
21	CHARALAMPOUS Miltiadi (CYP)	45	JACENKO A. (LAT)
22	GARAGAU Razvan (ROU)	46	BOUNTANIOTIS G. (GRE)
23	TSANTEKOV Achilles (GRE)	47	NAPSO A. (ISR)
24	AYDOGU Mehmet Ali (TUR)	48	BESTAEV D. (GRE)
	NIANE Elias (NOR)		

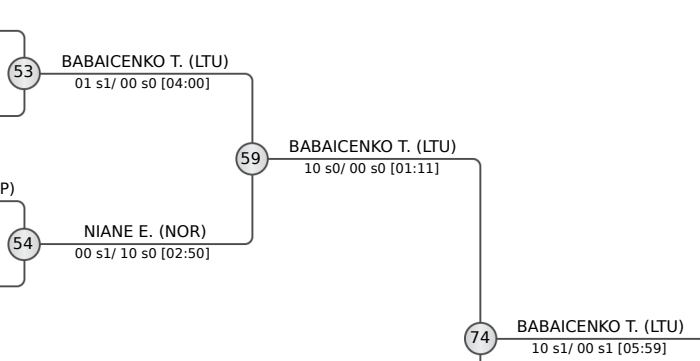

**POOL D**

25	JACENKO Arturs (LAT)	45	JACENKO A. (LAT)
26	MLADENOVIC Andrija (SRB)	46	BOUNTANIOTIS G. (GRE)
27	BOUNTANIOTIS Georgios (GRE)	47	NAPSO A. (ISR)
28	LAZAROV Ventsislav (BUL)	48	BESTAEV D. (GRE)
29	ACHLOW Boaz (ISR)	49	MUKHUM R. (KAZ)
30	CAPEZZUTO Antonio (ITA)	50	RAHMATOV A. (AZE)
31	NAPSO Aslan (ISR)	51	BUMAZKINS J. (LAT)
32	IAKOVOU Michalis (CYP)	52	GELASHVILI L. (GEO)
	MEHDIYEV Amin (AZE)		
	BESTAEV Dionysis (GRE)		

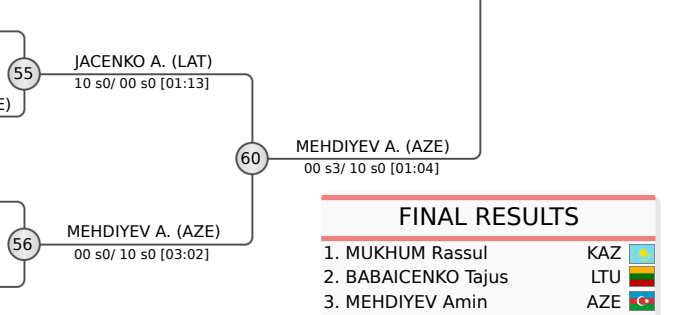

FINAL RESULTS		
1.	MUKHUM Rassul	KAZ
2.	BABAICENKO Tajus	LTU
3.	MEHDIYEV Amin	AZE
3.	BAKHTADZE Tsotne	GEO
5.	RAHMATOV Abdullah	AZE
5.	BUMAZKINS Jelisejs	LAT
7.	GELASHVILI Levan	GEO
7.	NAPSO Aslan	ISR

**REPECHAGE**

61	ORFANOS A. (CYP)	65	ORFANOS A. (CYP)
62	MARKOVIC M. (MNE)	66	MARKOVIC M. (MNE)
63	LARIOS A. (GRE)	67	BAKHTADZE T. (GEO)
64	BESTAEV D. (GRE)	68	NAPSO A. (ISR)
		69	RAHMATOV A. (AZE)
		70	GELASHVILI L. (GEO)
		71	BAKHTADZE T. (GEO)
		72	NAPSO A. (ISR)
		73	MUKHUM R. (KAZ)
		74	BABAICENKO T. (LTU)
		75	RAHMATOV A. (AZE)
		76	BAKHTADZE T. (GEO)
		77	MEHDIYEV A. (AZE)
		78	BAKHTADZE T. (GEO)
		79	MUKHUM R. (KAZ)

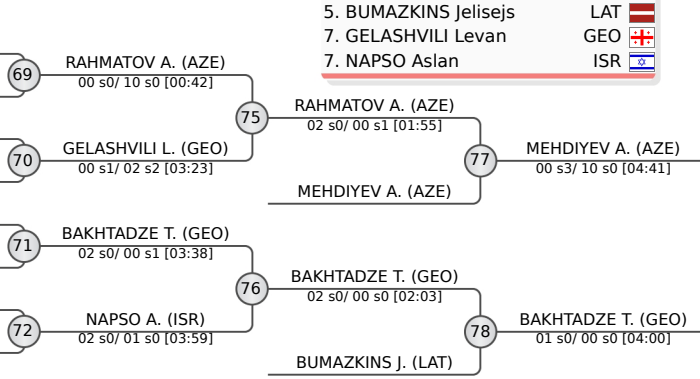



# Thessaloniki Cadet European Cup 2024

Greece, Thessaloniki, 23-24 Nov 2024

**-90 kg**  
Cadets (21)

**POOL A**

	KONCILIJA Dan	CRO
	SIMON Viktor	MNE
	PRENTZAS Pavlos	GRE
	PRUIDZE Saba	GEO
	GAL Ofri	ISR
	VALENTIN Jeremy	LUX

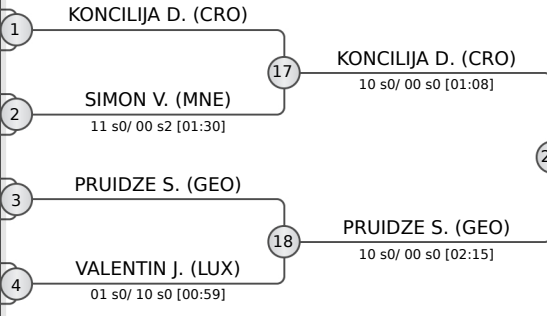

**POOL B**

	VUJICA Marko	CRO
	NAZLIS Dimitrios	GRE
	STANEV Zdravko	BUL
	DJINKIC Ivano	BIH
	SHOSHIN Nikita	IJF

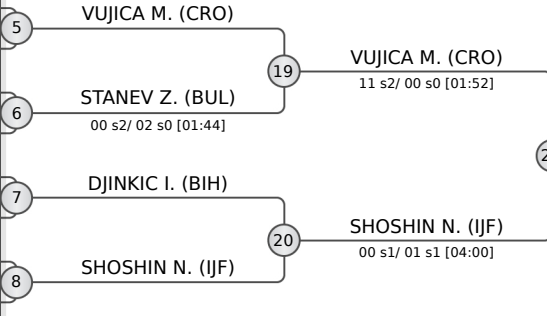

**POOL C**

	MILICEVIC Ivan	BIH
	RADULOVIC Jovan	MNE
	PASZEK Damian	POL
	HUSEYNOV Said	AZE
	KARAKLIDIS Gkiorgki	GRE

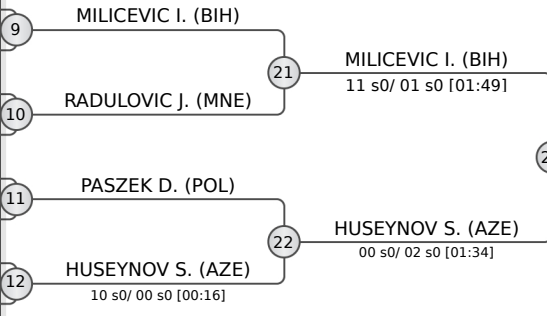

**POOL D**

	SIMIC Nemanja	SRB
	TZAGKIDIS Nikolaos	GRE
	SUNDBY Marius	NOR
	JURILJ Simun	CRO
	NEACSU Rares	ROU

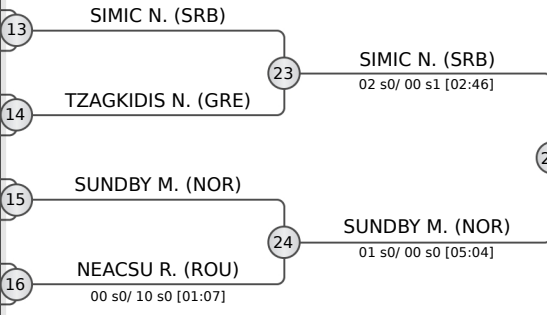

**REPECHAGE**

29 SIMON V. (MNE)	30 DJINKIC I. (BIH)	31 RADULOVIC J. (MNE)	32 TZAGKIDIS N. (GRE)
33 PRUIDZE S. (GEO)	34 VUJICA M. (CRO)	35 HUSEYNOV S. (AZE)	36 SUNDBY M. (NOR)

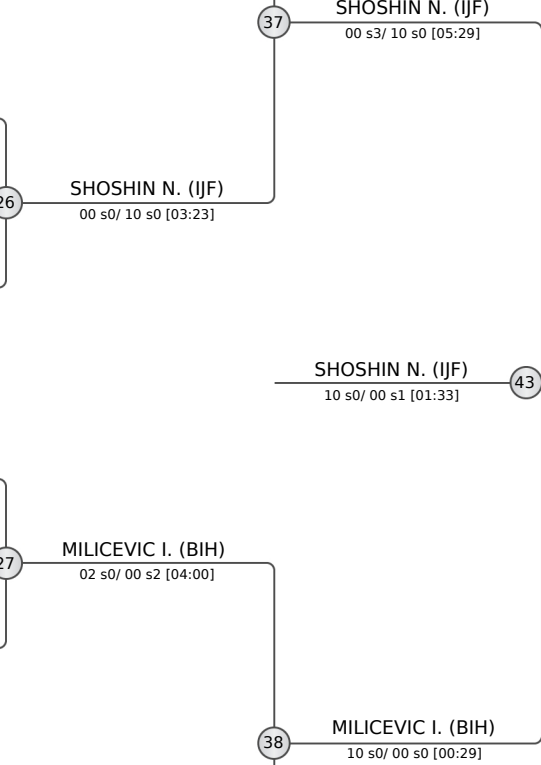
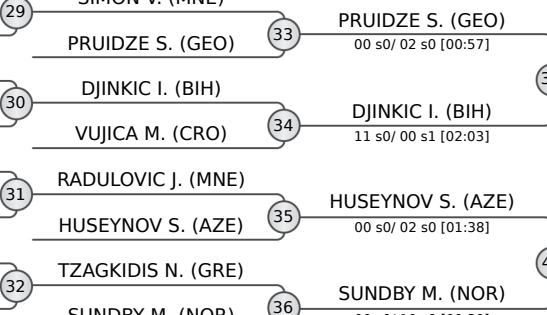

FINAL RESULTS	
1.	SHOSHIN Nikita IJF
2.	MILICEVIC Ivan BIH
3.	DJINKIC Ivano BIH
3.	SUNDBY Marius NOR
5.	SIMIC Nemanja SRB
5.	KONCILIJA Dan CRO
7.	PRUIDZE Saba GEO
7.	HUSEYNOV Said AZE





# Thessaloniki Cadet European Cup 2024

Greece, Thessaloniki, 23-24 Nov 2024

**+ 90 kg**  
Cadets (12)

**POOL A**

	AKHUNDOV Subhan	AZE
	BAZARKATOV Yeraly	KAZ
	CUIBUS Raul	ROU

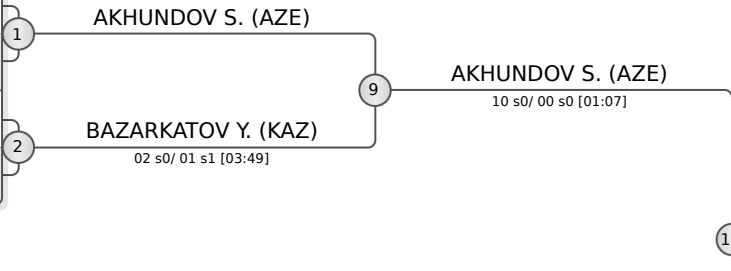

**POOL B**

	CORKOVIC Filip	SRB
	MASIMOV Javidan	AZE
	GULARASHVILI Viktor	GRE

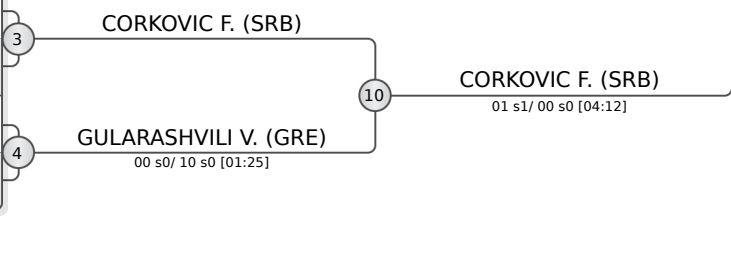

**POOL C**

	IVANKOVIC Luka	CRO
	ZARAFONITIS Alexios-Paisios	GRE
	FARZALIYEV Tunar	AZE

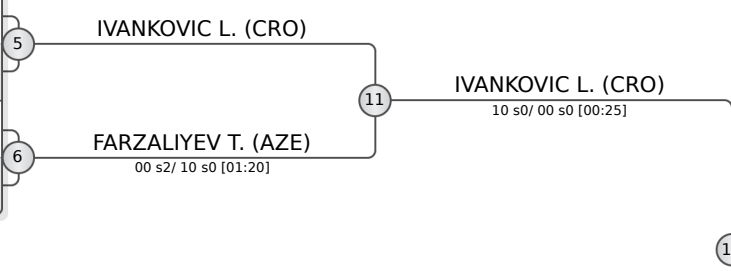

**POOL D**

	NOVAKOVIC Petar	SRB
	ZHAUDINOV Adilzhan	KAZ
	MALJEVIC Emir	MNE

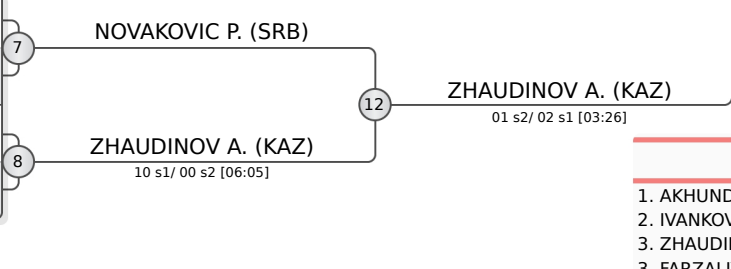

FINAL RESULTS		
1.	AKHUNDOV Subhan	AZE
2.	IVANKOVIC Luka	CRO
3.	ZHAUDINOV Adilzhan	KAZ
5.	BAZARKATOV Yeraly	KAZ
5.	CORKOVIC Filip	SRB
7.	GULARASHVILI Viktor	GRE
7.	NOVAKOVIC Petar	SRB

**REPECHAGE**

13	BAZARKATOV Y. (KAZ)
14	GULARASHVILI V. (GRE)
15	FARZALIYEV T. (AZE)
16	MALJEVIC E. (MNE)
16	NOVAKOVIC P. (SRB)





# Thessaloniki Cadet European Cup 2024

Greece, Thessaloniki, 23-24 Nov 2024

**-57 kg**  
Cadets (30)

**POOL A**

	SORELLI Giulia	ITA
	KOVACI Krista	ALB
	KADIC Iva	CRO
	GLIGA Ana	ROU
	HADAR Noa	ISR
	DAVAZE Isaure	FRA
	KESIDOU Christina	GRE

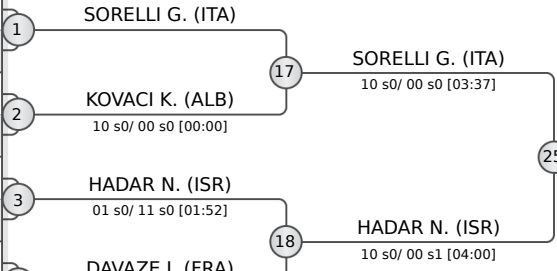

**POOL B**

	AZINOU Marina	CYP
	KRAUS Daria	ROU
	PAPADOPOULOU Despoina	GRE
	TRAAVIK Asal	NOR
	DUDKO Aleksandra	GBR
	CVETKOVIC Jana	SRB
	GAMIASHVILI Tamar	GEO
	CESLAUSKAITE Deimante	LTU

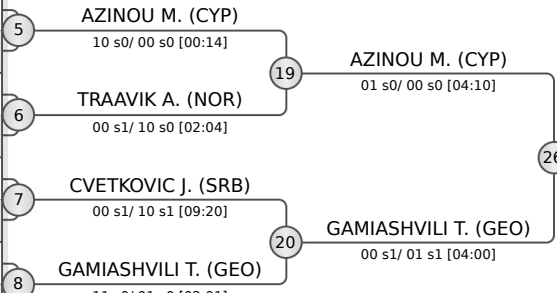

**POOL C**

	CAPEZZUTO Martina	ITA
	JASIKOVAC Nikolina	BIH
	CHRISTOPOULOU Evdokia	GRE
	PKHAKADZE Barbara	GEO
	TRIFKOVIC Iva	SRB
	PERY Noa	ISR
	REVEILLON Louanne	FRA

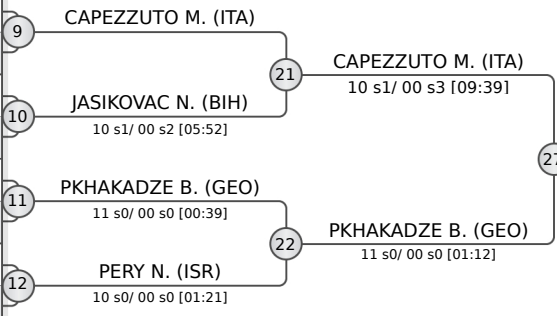

**POOL D**

	VEINHANDL OBAID Haya	SLO
	KAKARANTZA Ioanna	GRE
	STAIKU Patricia	ROU
	DOS REIS Constance	FRA
	SKOMERSIC Maria	CRO
	SEKULOVIC Milena	SRB
	KHEGAY Kira	KAZ
	BESTAV Selin	TUR

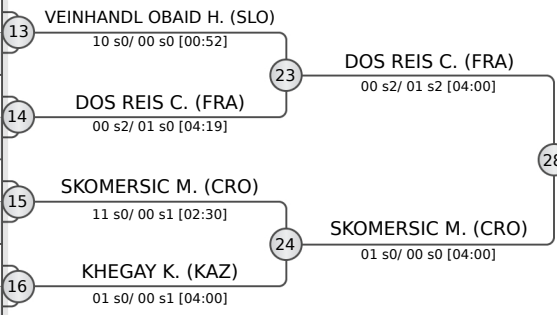

**REPECHAGE**

GLIGA A. (ROU)	29	GLIGA A. (ROU)	33
DAVAZE I. (FRA)		SORELLI G. (ITA)	
CESLAUSKAITE D. (LTU)			
CVETKOVIC J. (SRB)	30	CESLAUSKAITE D. (LTU)	34
		AZINOU M. (CYP)	
JASIKOVAC N. (BIH)	31	JASIKOVAC N. (BIH)	35
SEKULOVIC M. (SRB)		PKHAKADZE B. (GEO)	
KHEGAY K. (KAZ)	32	KHEGAY K. (KAZ)	36
		DOS REIS C. (FRA)	

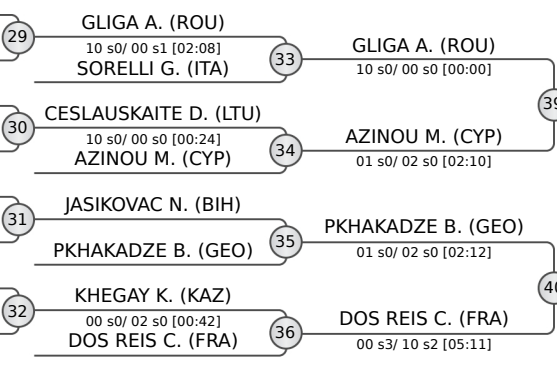

FINAL RESULTS	
1.	CAPEZZUTO Martina ITA
2.	GAMIASHVILI Tamar GEO
3.	AZINOU Marina CYP
3.	DOS REIS Constance FRA
5.	SKOMERSIC Maria CRO
5.	HADAR Noa ISR
7.	GLIGA Ana ROU
7.	PKHAKADZE Barbara GEO





# Thessaloniki Cadet European Cup 2024

Greece, Thessaloniki, 23-24 Nov 2024

**-63 kg**  
Cadets (25)

**POOL A**

	MATSIRIDI Sophia	GRE
	UNGUREANU Bianca	ROU
	HUBERT Prisca	FRA
	IMERI Sara	CRO
	RUBANOVICI Dorina	MDA
	CHRISAKI Anni-Iris	GRE
	COVIC STANIC Lana	BIH

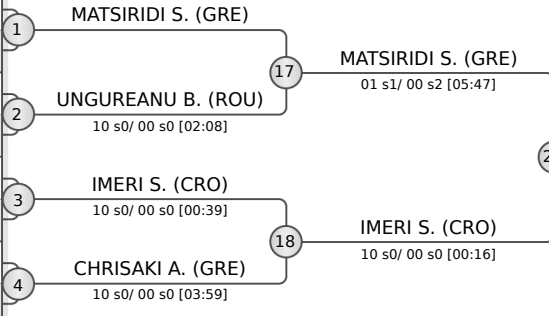

**POOL B**

	BOGDANOVSKA Iva	MKD
	MATSIRIDI Drosia	GRE
	JOVICIC Sofija	SRB
	THOMSON Maia	CAN
	MITEVA Elizabeth	BUL
	PAPASTERGIOU Anna	GRE

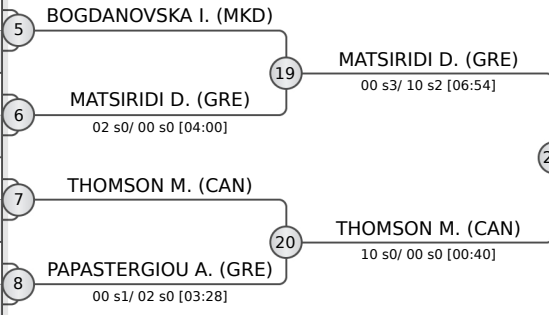

**POOL C**

	NATELAURI Mariam	GEO
	DIALLO Malika	FRA
	IMERI Esra	CRO
	GRAMBO Anna	NOR
	DOUROU Lydia	GRE
	FROSONI Giorgia	ITA

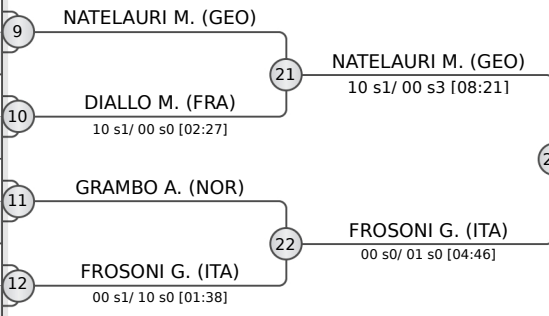

**POOL D**

	DALMASSO Madeleine	FRA
	OURANITSA Chrysoula-Stavroula	GRE
	TODOROVA Elitsa	BUL
	AUBERT GOMEZ Maya	GBR
	AKRIVOULI Eftymia	GRE
	LULEDZIJA Marija	BIH

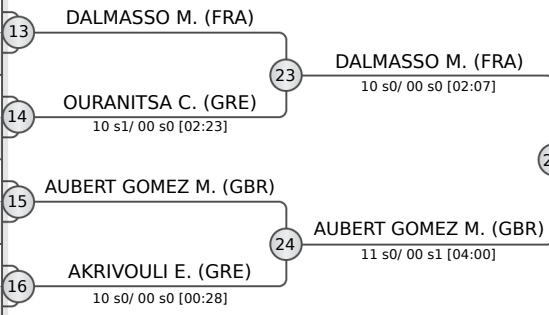

**REPECHAGE**

RUBANOVICI D. (MDA)	CHRISAKI A. (GRE)	29
CHRISAKI A. (GRE)	MATSIRIDI S. (GRE)	33
PAPASTERGIOU A. (GRE)	MATSIRIDI D. (GRE)	34
DOUROU L. (GRE)	GRAMBO A. (NOR)	31
GRAMBO A. (NOR)	OURANITSA C. (GRE)	32

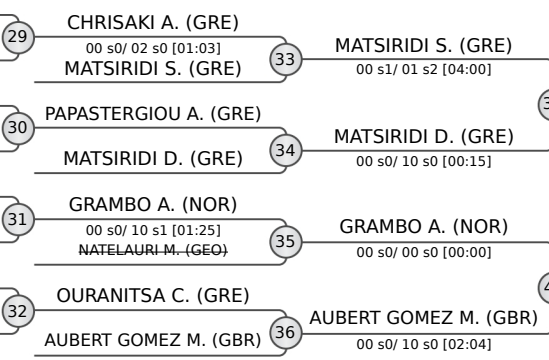

FINAL RESULTS	
1. FROSONI Giorgia	ITA
2. THOMSON Maia	CAN
3. DALMASSO Madeleine	FRA
3. AUBERT GOMEZ Maya	GBR
5. MATSIRIDI Sophia	GRE
5. IMERI Sara	CRO
7. MATSIRIDI Drosia	GRE
7. GRAMBO Anna	NOR





# Thessaloniki Cadet European Cup 2024

Greece, Thessaloniki, 23-24 Nov 2024

**-70 kg**  
Cadets (14)

**POOL A**

	SLACEK Nika	CRO
	PAPAIOANNOU Maria Eleni	GRE
	VLAHOVIC Teodora	MNE

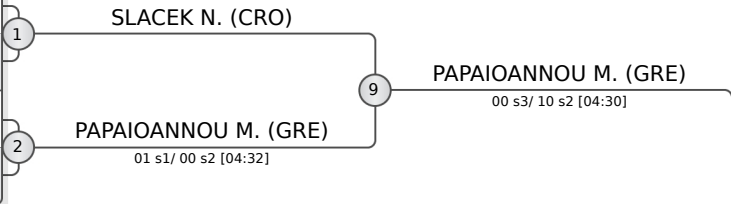

**POOL B**

	KLINGER Johanna Elisabeth	BIH
	MICHAIL Maria	CYP
	HUDIKA Vita	CRO
	KURDGELIA Elene	GEO

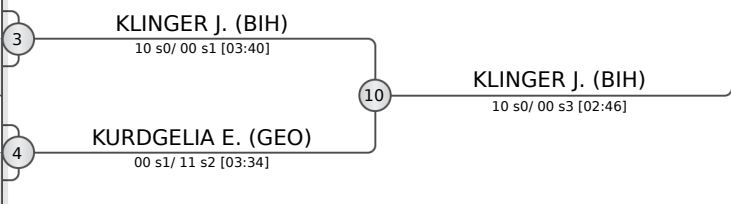

**POOL C**

	ROBAKIDZE Keti	GEO
	MARKHVAIDZE Lizi	GEO
	KNAFELC Noeli	SLO

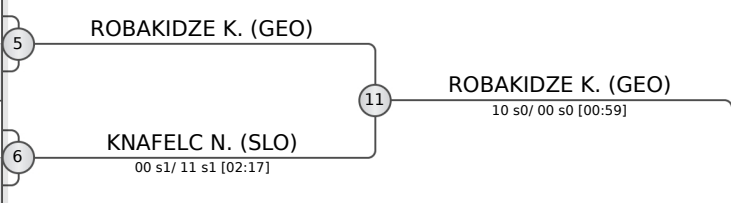

**POOL D**

	DZIDIC Korina	BIH
	ILIC Sara	SRB
	MITAKIDOU Ilektra-Evangelia	GRE
	APETREI Marianne Alexandra	ITA

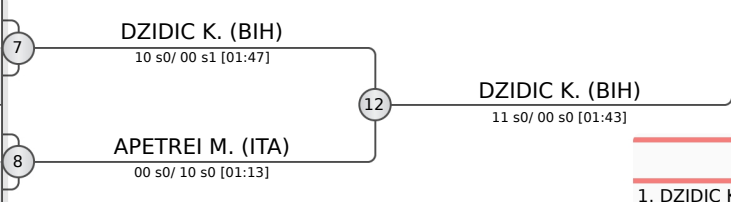

**REPECHAGE**

VLAHOVIC T. (MNE)	13
SLACEK N. (CRO)	14
MICHAIL M. (CYP)	15
KURDGELIA E. (GEO)	16
KNAFELC N. (SLO)	17
ILIC S. (SRB)	18
APETREI M. (ITA)	19

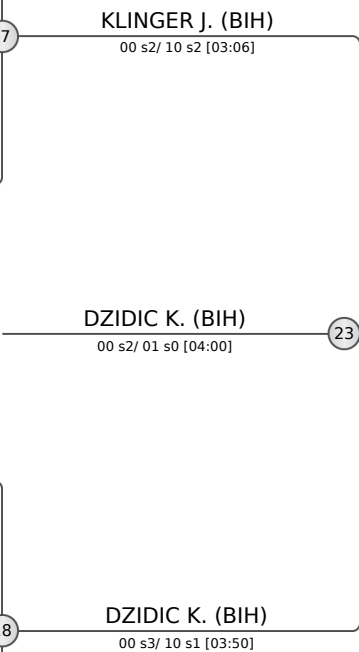
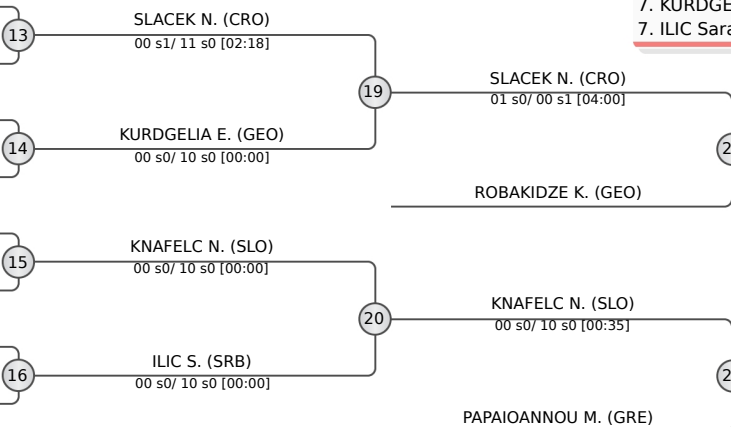

FINAL RESULTS		
1.	DZIDIC Korina	BIH
2.	KLINGER Johanna Elisabeth	BIH
3.	SLACEK Nika	CRO
3.	PAPAIOANNOU Maria Eleni	GRE
5.	ROBAKIDZE Keti	GEO
5.	KNAFELC Noeli	SLO
7.	KURDGELIA Elene	GEO
7.	ILIC Sara	SRB





# Thessaloniki Cadet European Cup 2024

Greece, Thessaloniki, 23-24 Nov 2024

**+ 70 kg**  
Cadets (8)

**POOL A**

KVARATSKHELIA Nona GEO  
 OGKANESIAN Natalia GRE

1 KVARATSKHELIA N. (GEO)  
02 s0/ 00 s0 [01:10]

**POOL B**

REPIAKH Aleksandra IJF  
 CHERKELIEVA Maria BUL

2 REPIAKH A. (IJF)  
11 s0/ 00 s0 [01:34]

**POOL C**

SCHIAVON Carlotta ITA  
 KAPIANIDZE Nia GEO

3 SCHIAVON C. (ITA)  
01 s0/ 00 s0 [04:00]

**POOL D**

NIKETIC Leona CRO  
 KAJTAZOVIC Danijela BIH

4 KAJTAZOVIC D. (BIH)  
01 s1/ 10 s0 [03:19]

5 REPIAKH A. (IJF)  
00 s0/ 01 s1 [04:00]

6 SCHIAVON C. (ITA)  
02 s0/ 00 s0 [00:36]

11 REPIAKH A. (IJF)  
10 s0/ 00 s0 [01:07]

**REPECHAGE**

OGKANESIAN N. (GRE)  
CHERKELIEVA M. (BUL)

7 CHERKELIEVA M. (BUL)  
00 s0/ 02 s1 [02:58]

KAPIANIDZE N. (GEO)  
NIKETIC L. (CRO)

8 NIKETIC L. (CRO)  
00 s0/ 10 s0 [01:21]

9 CHERKELIEVA M. (BUL)  
11 s1/ 01 s0 [05:07]

10 KVARATSKHELIA N. (GEO)  
11 s1/ 01 s0 [05:07]

FINAL RESULTS		
1.	REPIAKH Aleksandra	IJF
2.	SCHIAVON Carlotta	ITA
3.	CHERKELIEVA Maria	BUL
3.	KVARATSKHELIA Nona	GEO
5.	KAJTAZOVIC Danijela	BIH
5.	NIKETIC Leona	CRO

